

Profile MOD-50

Ref. A18047

Ref. arch 18047

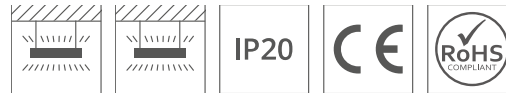
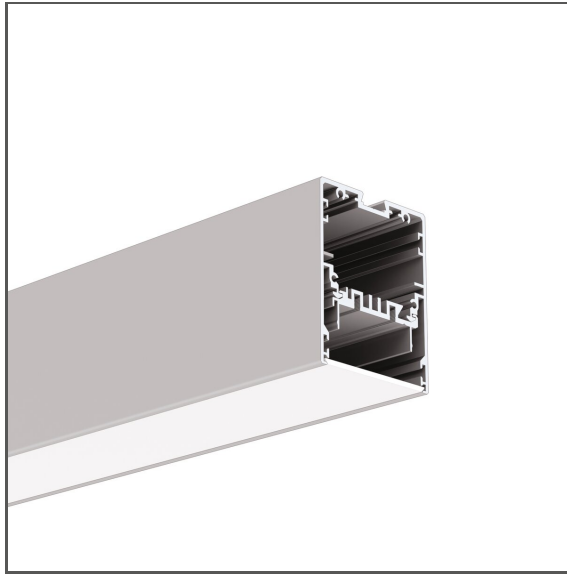

- Installation from below, wall to wall
- Possibility to obtain UGR < 19
- Up/down lighting
- Compartment for driver and electrical components
- Easy maintenance

APPLICATION

- main and decorative lighting

MOUNTING

- suspended, using dedicated accessories
- can be easily connected into runs and systems

ADDITIONAL INFORMATION

- the luminous efficiency can be increased by 20% with the use of REFLEX 16-60 reflectors
- both LED strips and LED current modules can be used
- safety due to high vibration resistance
- standard lengths of KLUŚ profiles and covers: 1000 mm (tolerance ± 1.5 mm) and 2005 mm / 3010 mm (tolerance + 5 mm); for selected covers: 6050 mm, 10050 mm (tolerance + 5 mm)
- when choosing a different length of profiles / covers than available in the standard, you should additionally choose the cutting service at KLUŚ

TECHNICAL DRAWING

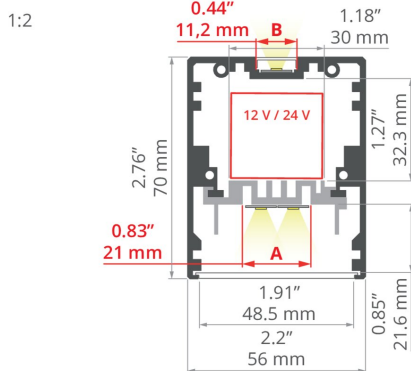

TECHNICAL SPECIFICATIONS

Material	aluminum
Possible fixture IP	20
Possible fixture shapes	linear, polygonal
Profile cross-section	rectangular
Width	56 mm
Height	70 mm
LED gluing width A	21 mm
LED gluing width B	11.2 mm
Number of LED strips A (8 mm wide)	1
Compartment for power supply	yes
Possibility of obtaining a line of light	yes
Building type	Commercial, Retail, Entertainment/ Arts, HoReCa object
Facility zone	office, communication routes and corridors, conference room, lobby / foyer
The cover is cut to the length of the profile	yes
Can be easily connected into runs	yes

Color	Length	Ref
■ silver anodized	1000 mm	A18047A_1 18047ANODA_1
	2005 mm	A18047A_2 18047ANODA_2
	3010 mm	A18047A_3 18047ANODA_3
■ black anodized	1000 mm	A18047A07_1 18047K7_1
	2005 mm	A18047A07_2 18047K7_2
	3010 mm	A18047A07_3 18047K7_3
□ white lacquered	1000 mm	A18047L100D_1 18047L90100D_1
	2005 mm	A18047L100D_2 18047L90100D_2
	3010 mm	A18047L100D_3 18047L90100D_3

Profile MOD-50

Ref. A18047

Ref. arch 18047

Wire out back of extrusion	yes
Two directional lighting for suspended fixtures	yes

SAMPLE PROJECTS

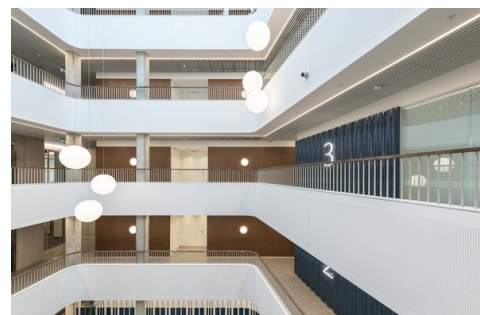









Profile MOD-50

Ref. A18047

Ref. arch 18047

RELATED ACCESSORIES > RELATED COVERS

NAME	MATERIAL	MATERIAL TRANSMITTANCE	COLOR	REF.
HS		PC	73 % <input type="checkbox"/> frosted	B17208M 1369
			94 % <input checked="" type="checkbox"/> clear	B17208T 1370
KA		PC	63 % <input type="checkbox"/> frosted	B17035M 17035
			91 % <input checked="" type="checkbox"/> clear	B17035T 17036
KA-COM		PVC	70 % <input type="checkbox"/> frosted	B17179M 17179
			93 % <input checked="" type="checkbox"/> clear	B17179T 17180
KA-PRO		PC	67 % <input type="checkbox"/> frosted	B17064M 17064
			94 % <input checked="" type="checkbox"/> clear	B17064T 17065
LIGER		PC	70 % <input type="checkbox"/> frosted	B17037M 17037
			32 % <input checked="" type="checkbox"/> black	B17037C 17040
POL-50		PC	73 % <input type="checkbox"/> frosted	B17058M 17058
PRS-50		PC	85 % <input checked="" type="checkbox"/> clear	B17169T 17169
B17169TOP 17169OP				
JUN-50		PMMA	92 % <input checked="" type="checkbox"/> clear	B17056P 17056

RELATED ACCESSORIES > RELATED END CAPS

NAME	MATERIAL	COLOR	REF.
MOD-50		<input checked="" type="checkbox"/> gray	C28024C02 24329
		<input type="checkbox"/> white	C28024C10 24406
		<input checked="" type="checkbox"/> black	C28024C07 24405

Profile MOD-50

Ref. A18047

Ref. arch 18047

RELATED ACCESSORIES > RELATED LED > CRI 95+

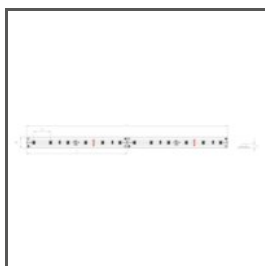

K-CR-1210-24V
K-CR-1210-24
Ref. arch K-CR-1210-24V

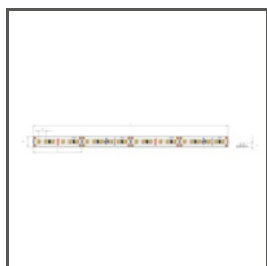

K-CR-1220-24V
K-CR-1220-24
Ref. arch K-CR-1220-24V

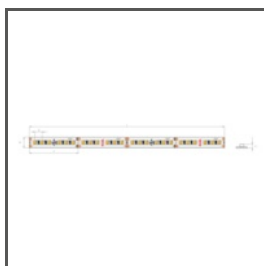

K-CR-1275-24V
K-CR-1275-24
Ref. arch K-CR-1275-24V

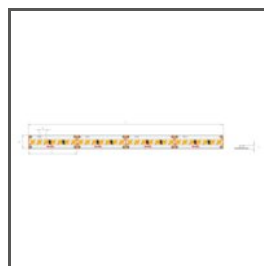

K-CR-1820-HD-24V
K-CRHD-1820-24
Ref. arch K-CR-1820-HD-24V

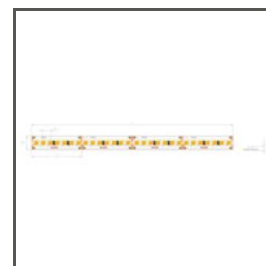

K-CR-1910-HD-24V
K-CRHD-1910-24
Ref. arch K-CR-1910-HD-24V

RELATED ACCESSORIES > RELATED LED > HIGH EFFICACY

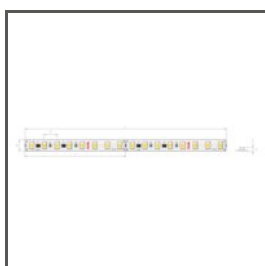

K-HE-0480-HD-24V
K-HEHD-0480-24
Ref. arch K-HE-0480-HD-24V



K-HE-0960-HD-24V
K-HEHD-0960-24
Ref. arch K-HE-0960-HD-24V

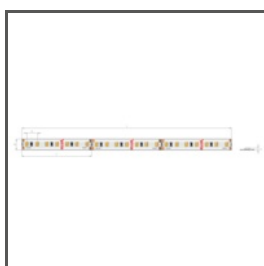

K-HE-1440-HD-24V
K-HEHD-1440-24
Ref. arch K-HE-1440-HD-24V

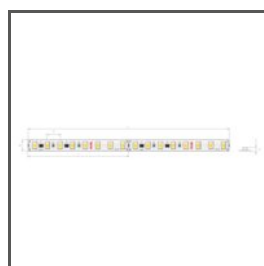

K-HE-1920-HD-24V
K-HEHD-1920-24
Ref. arch K-HE-1920-HD-24V

RELATED ACCESSORIES > RELATED LED > WHITE MONO



K-0530-HD-24V
K-HD-0530-24
Ref. arch K-0530-HD-24V



K-0480-24V
K-0480-24
Ref. arch K-0480-24V



K-0960-24V
K-0960-24
Ref. arch K-0960-24V



K-1440-24V
K-1440-24
Ref. arch K-1440-24V



K-2400-24
K-2400-24



K2-1920-24
K2-1920-24



K3-2880-24
K3-2880-24

Profile MOD-50

Ref. A18047

Ref. arch 18047

RELATED ACCESSORIES > OTHER RELATED ACCESSORIES > ADDITIONAL ITEMS



REFLECTOR
REFLEX 16-60
C24536C10
Ref. arch 17003



SCREW
2.9X6.5 DIN7981F
Z70283
Ref. arch 70283



CANOPY
Fi-60mm
C24540

RELATED ACCESSORIES > OTHER RELATED ACCESSORIES > CONNECTORS



CONNECTOR
ZM-180
C28075N00
Ref. arch 40693

RELATED ACCESSORIES > OTHER RELATED ACCESSORIES > FASTENERS AND HEADS FOR PROFILES



FASTENER
M4-12
C28118N00, C28118C10,
C28118C07
Ref. arch 42246, 42246L9010,
42246L9005

RELATED ACCESSORIES > OTHER RELATED ACCESSORIES > OTHER

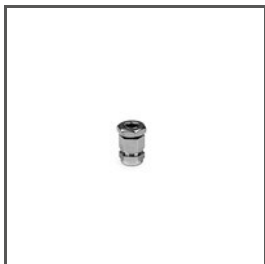

GLAND
M8x1
C42265N00
Ref. arch 42265

Profile MOD-50

Ref. A18047

Ref. arch 18047

RELATED ACCESSORIES > OTHER RELATED ACCESSORIES > SUSPENSION AND MOUNTING SETS



FASTENER SET

RG-1

C28230P00, C28230P01,
C28230L10, C28230L07

Ref. arch 42647NI, 42647GSS,
42647L9010, 42647L9005